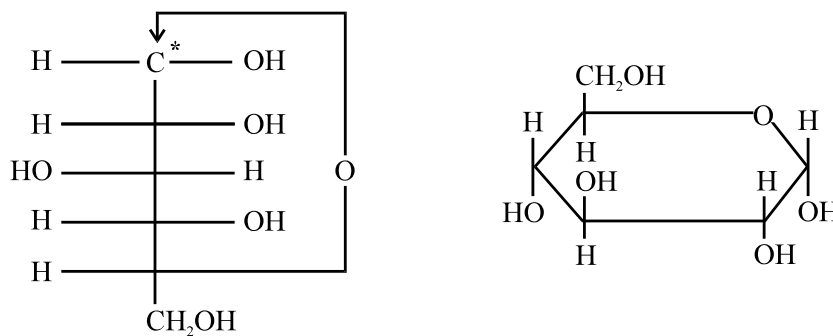
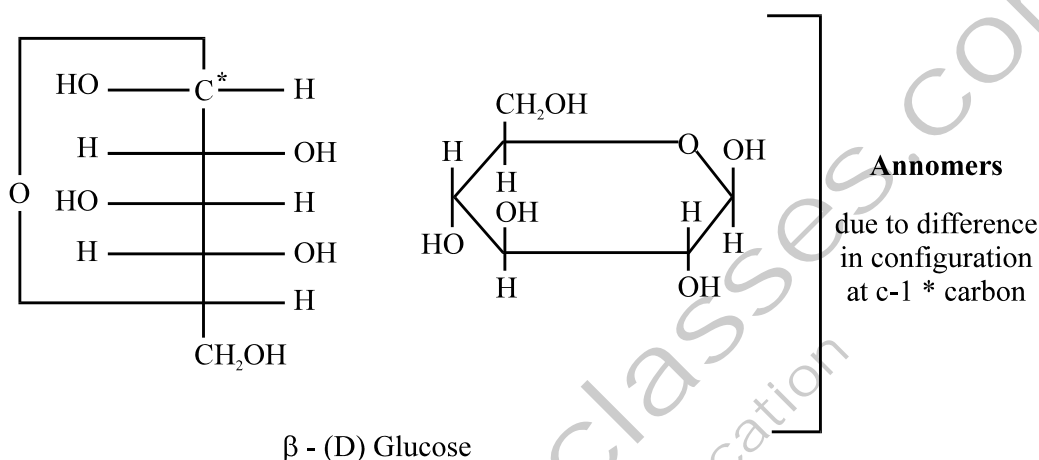

BIO-MOLECULES

www.einsteinclasses.com
Free Quality Education

 α - (D) Glucose β - (D) Glucose**MUTOROTATION:**

When 2 forms α_D glucose are dissolved in H_2O and allowed to stand in water, then specific rotation changes slowly to $+52.5^\circ$.

This spt. change in specific rotation of an optically active glucose when dissolved in water is Mutarotation. Also shown by Fructose.

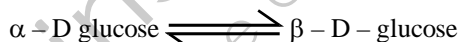
**C4 DISACCHARIDES:**

disaccharides $\xrightarrow{H_2O}$ 2 moles of monosaccharides (same or either different)

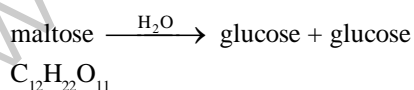
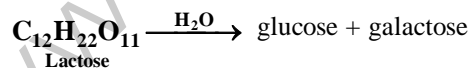
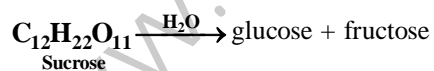

The disaccharides may be reducing or non-reducing depending upon position of linkages

↓
This linkage is
GLYCOSIDIC LINKAGE

between 2 monosaccharides units.

- (i) If the glycoside linkage involves the carbonyl functional group of both monosaccharides units, the resulting disaccharides is non-reducing e.g. Sucrose.
- (ii) If one of carbonyl functional group of any monosacchride units is free, then resulting disaccharide would be reducing e.g. Maltose & Lactose.

SUCROSE : (Sugarcane, beet root) → property → colourless, water soluble and sweet substance.

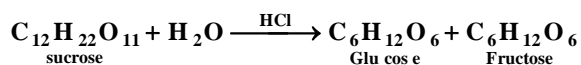

Sucrose is dextrorotatory but after hydrolysis gives dextrorotatory glucose + leavo fructose. (mixture is Laevorotary). (partial reacmisation)) as leavo rotation is more than dextorotation of glucose.

- ⇒ Change in rotation ⇒ **INVERSION**
Mixture is **INVERT SUGAR**.

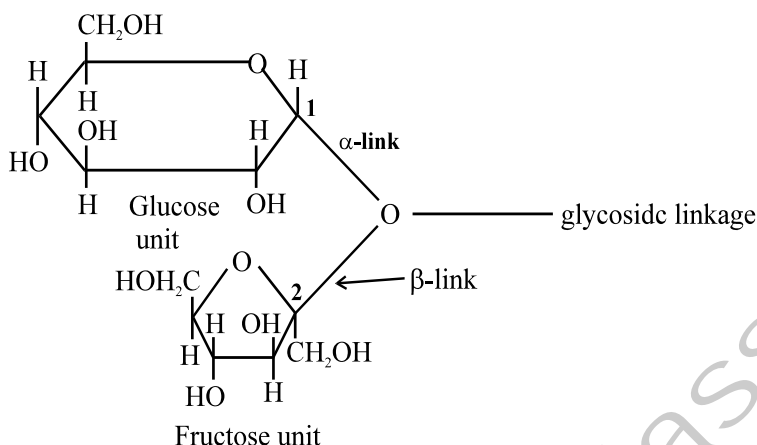

+ → given to optically active compound which rotates plane of polarized light clockwise or left

Polysaccharide → **Starch** → occur in all plants

- (i) Starch occur in form of granules, which vary in size and shape depending on their plant source
- (ii) Starch is amorphous powder, insoluble in cold water
- (iii) Starch solution gives blue colour in water disappear on heating
- (iv) On hydrolysis it break down to molecules of variable size completely

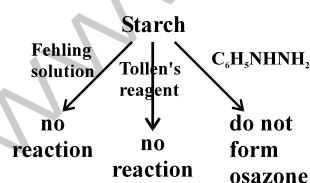
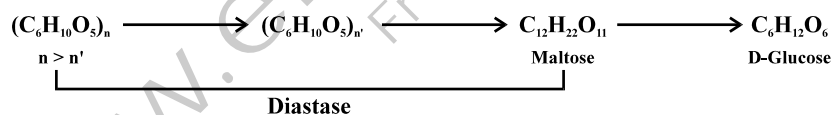

- (v) It indicates the presence of glucosidic linkage

(vi) Starch is a mixture of two polysaccharide

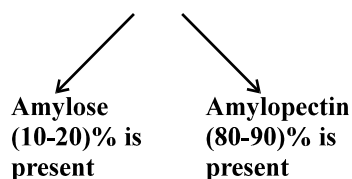

Amylose

- water soluble & give blue colour with I_2
- having α -D-Glucose units joined together linkage involving C_1 and C_4 of another glucose
- It can have 100-3000 D-Glucose

Amylopectin

Branched chain polysaccharide insoluble in water, which does not give blue colour with I_2 .

It is composed of 25-30 α -D-glucose units by α -Glucosidic joined by α -D-glycosidic linkage between C-1 of one glucose unit and C_4 of next glucose unit (similar to amylose)

However these chains are connected with each other by 1,6-linkages.

Starch is major food material. It is hydrolysed by enzyme amylase present in saliva. The end product is glucose which is essential nutrient.

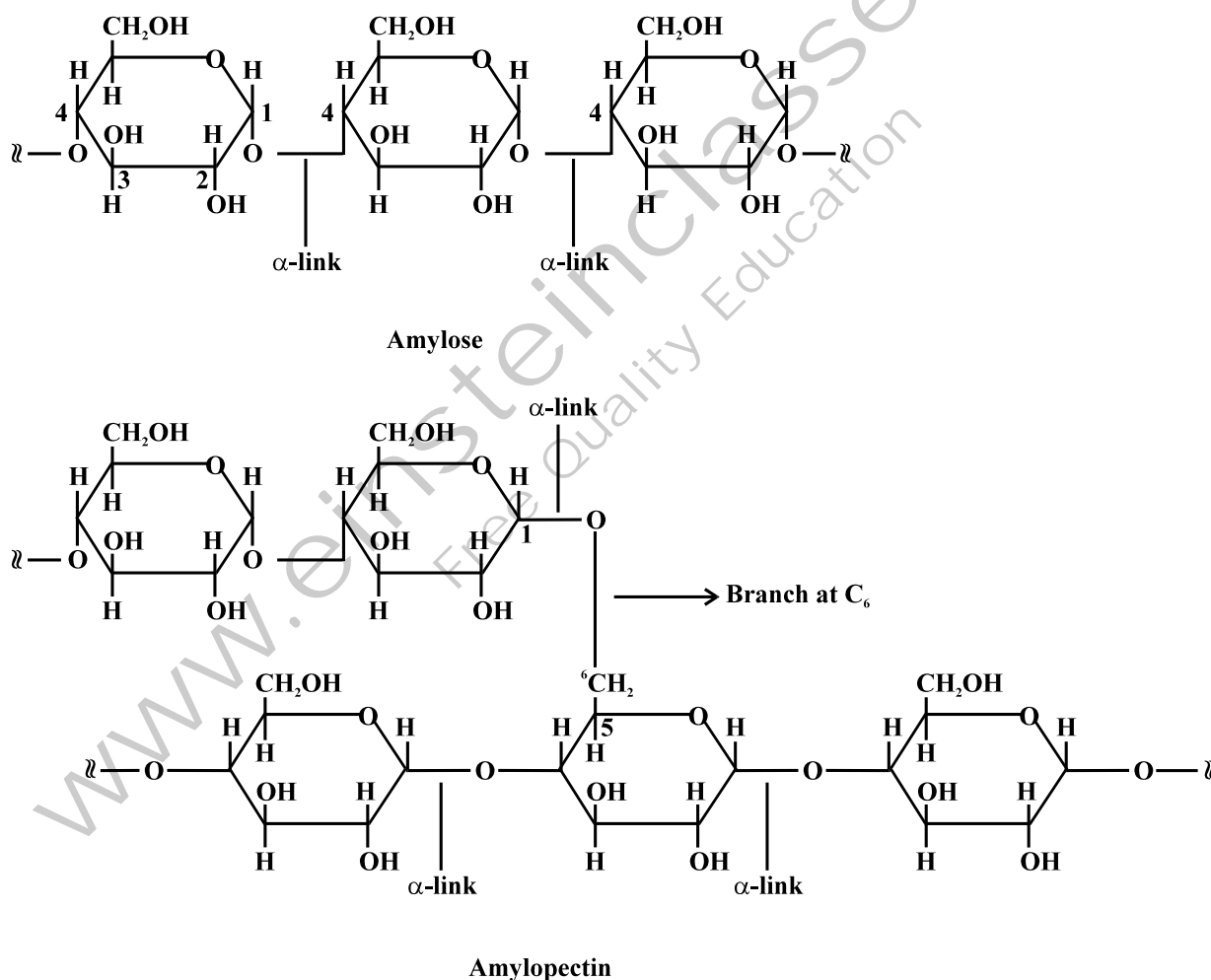

C5 Lipid:

Lipid are naturally occurring compound related to fatty acids and it include Fats, Oils, Waxes.

In body they serve as source of energy, They are store in adipose tissues. They are lyophobic in nature and soluble in organic solvent. Phospholipid is important constituent of cell membrane

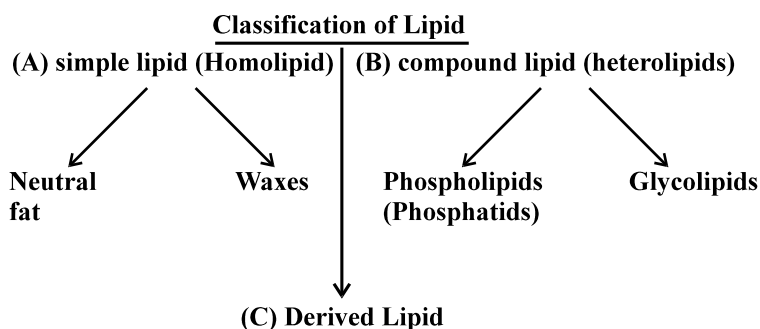

(A) Simple Lipid : They are triglycerides i.e. esters of glycerol with long chain fatty acids.

(i) Fatty acids have even numbers of carbons may be saturated or unsaturated.

Unsaturated/Saturated Fatty Acids

(ii) The three fatty acid in triglycerides may be same or different.

(iii) Fats are glycerides of saturated fatty acids e.g. tripalmitin and tristearin.

(iv) Oils contain unsaturated fatty acids e.g. triolein, α -oleo- β -palmito- α -stearin is an example of mixed triglyceride.

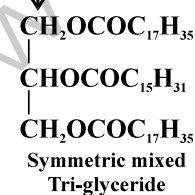
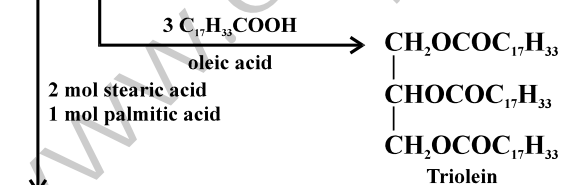
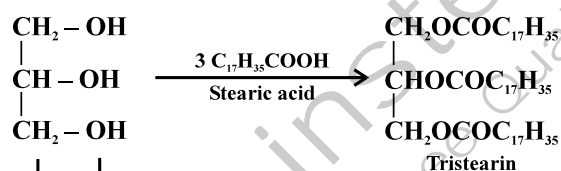
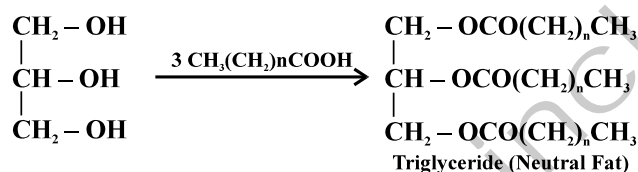

The presence of double bond with less stable cis stereochemistry in unsaturated fatty acid. In oleic acid it is at C-9. In linoleic acid $C_{17}H_{31}COOH$ at C9 & C12. In linoleic acid $C_{17}H_{29}COOH$ at C9 & C12. In solid state the molecules of saturated fatty acids fit closely due to zig-zag tetrahedral structure. The cis unsaturated fatty acid chains have a bend at the double bond & do not fit clearly resulting in lowering of melting point of the fat. Application of lipid : Fats are important food reserves of animals and plant cells. Phospholipid are structural component of cell memberane and are also used as detergent to emulsify fat for transport within the body.

Proteins :

Proteins are high polymers. They are polyamides which contain C, H, N, O and S. Proteins are derived from α -amino carboxylic acid monomers. A simple protein may contain hundreds or even thousands of these amino acid units. In living organism, twenty α -amino acids occur which combine to form different protein molecules.

- (i) **Amino Acid** : A simple α -amino acid can be represented as $R - \overset{\alpha\text{-C-atom}}{\underset{\substack{| \\ \text{NH}_2 \\ \text{(amino acid)}}}{\text{CH}}} - \text{COOH}$ (carboxy group).

Due to the transfer of proton from carboxy to the amino group, α -amino acids exist as dipolar ions or zwitter ions. Amino acids contain an acidic (carboxyl group) and a basic (amino group) within the same molecule. In aqueous solution, the carboxyl group loses a proton while the amino group accepts it. As a result, a dipolar or zwitter ion is formed. In zwitter ionic form, α -amino acids show amphoteric behaviour as they react with both acids and bases. In the acidic medium, COO^- ion of the zwitter ion accepts a proton

to form the cation (I) while in the basic medium, $\overset{+}{\text{N}}\text{H}_3$ ion loses a proton to form the anion (II).

The amino acids are of two types :

- (i) Non-essential amino acids
- (ii) Essential amino acids

α -Amino acids which are needed for health and growth of human beings but are not synthesised by the human body are called essential amino acids. For example, valine, leucine, arginine, etc. On the other hand, α -amino acids which are needed for health and growth of human beings and are synthesised by the human body are called non-essential amino acids. For example, glycine, alaline, glutamine, etc.

Polypeptide Formation :

Peptide bond : Proteins are condensation polymers of α -amino acids in which the same or different α -amino acids are connected by peptide bonds. Peptide bond is an amide linkage formed between $-\text{COOH}$ group of one α -amino acid and NH_2 group of the other α -amino acid by loss of a molecule of water. For example :

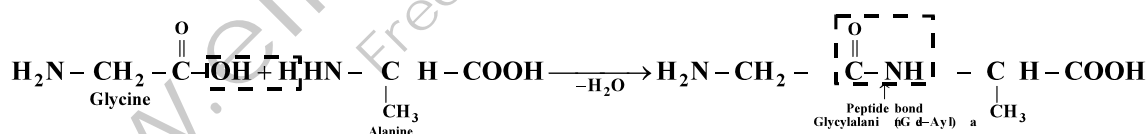

Structure of Proteins : Proteins have three structures :

- (i) Primary structure
- (ii) Secondary structure
 - (a) α -helix structure
 - (b) β -pleated structure
- (iii) Tertiary structure
 - (a) Fibrous structure
 - (b) Glubular structure

Primary structure : Proteins may contain one or more polypeptide chains. Each polypeptide chain has a large number of α -amino acids which are linked to one another in a specific manner. The specific sequence in which the various α -amino acids present in a protein are linked to one another is called its primary structure.

Secondary structure : The fixed conformation which the polypeptide chains assume as a result of hydrogen bonding is called the secondary structure of the proteins. The two types of secondary structures are : α -helix and β -pleated sheet structure

The α -helix structure of proteins is stabilised by intramolecular H-bonding between C = O of one amino acid residue and the N – H of the fourth amino acid residue in the chain.

Tertiary structure : It implies the three dimensional structure of proteins.

Globular proteins : This structure results when the chains of polypeptides coil around to give spherical shape. These proteins are usually soluble in water. Insulin and albumin are the common examples of globular proteins.

Fibrous proteins : When the polypeptide chains run parallel and are held together by hydrogen bond and disulphide bond, then fibre-like structure is obtained. Such proteins are called fibre proteins. Fibre proteins are insoluble in water. Some examples of fibrous proteins are keratin and myosin.

Denaturation of protein : Each protein in the biological system has a unique three-dimensional structure and has specific biological activity. This is called native form of a protein. When a protein in its native form is subjected to physical changes such as change in temperature, pH etc., hydrogen bonds are broken. Consequently, unfolding of protein molecule occurs and the protein loses its biological activity. This loss of biological activity is called denaturation. During denaturation, 2^0 and 3^0 structures of proteins are destroyed but 1^0 structure remains intact. An example of denaturation of proteins is the coagulation of albumin present in the white of an egg.

C6 Enzymes :

Enzymes are biological catalysts. Each biological system requires a different enzymes. thus, in contrast to conventional catalysts, enzymes are very specific and efficient in their action. They are required in only small quantity and work at optimum temperature (310 K) and pH (7.4) under one atmospheric pressure. Chemically, they are globular proteins. However, some enzymes are also associated with some non-protein component called the cofactor for their activity.

Cofactors are of two types :

- (a) **Inorganic ions** such as Zn^{2+} , Mg^{2+} , Mn^{2+} , Fe^{2+} , Cu^{2+} , Co^{2+} , etc.
- (b) **Organic molecules** : These are also of two types :
 - (i) **Coenzymes** : These are usually derived from vitamins such as thiamine, riboflavin, etc.
 - (ii) **Prosthetic group** : These are also derived from vitamins such as biotin but are tightly held to the protein molecule by covalent bonds. They can be separated only by careful hydrolysis.

C7 Nucleic Acid :

Nucleic acids are biomolecules which are found in the nuclei of all living cells in form of nucleoproteins or chromosomes (proteins containing nucleic acids as the prosthetic group).

Nucleic acids are of two types :

- (i) deoxyribonucleic acid (DNA) and
- (ii) ribonucleic acid (RNA).

Important functions of nucleic acids :

- (i) DNA is responsible for transmission of hereditary effects from one generation to another. This is due to the unique property of replication during cell division and two identical DNA strands are transferred to the daughter cells.
- (ii) DNA and RNA are responsible for protein synthesis needed for the growth and maintenance of our body. Actually the proteins are synthesised by various RNA molecules (r-RNA, m-RNA and t-RNA) in the cell but the message for the synthesis of a particular protein is given by DNA molecules.

DNA : It occurs in the nucleus of the cell. The two strands in DNA molecule are held together by hydrogen bonds between purine base of one stand and pyrimidine base of the other and vice versa. Because of different sizes and geometries of the bases, the only possible pairing in DNA are G (guanine) and C (cytosine) through three H-bonds, i.e, (C \equiv G) and T (thymine) through two H-bonds (i.e., A = T). Due to this

base-pairing principle, the sequence of bases in one strand automatically fixes the sequence of bases in the other strand. Thus, the two strands are complimentary and not identical

RNA : It occurs in the cytoplasm of the cell. The sugar present in RNA is D(-)-ribose. It has a **single-stranded** α -helix structure. In RNA, purine base are adenine (A) and guanine (G) while pyrimidine bases are cytosine (C) and uracil (U). RNA usually does not undergo replication. It controls the synthesis of proteins.

C8 Vitamins :

They are the chemical substances which are needed in small amounts for the growth and health of human beings. Vitamins cannot be synthesised in the body (except Vitamin D) and hence must be supplied in the food. Their deficiency can cause one or the other disease. Vitamin D may be produced in the skin by the irradiation of sterols present in oils and fats.

Vitamins are classified into two groups depending upon their solubility :

- (i) **Water soluble vitamins :** Vitamin B-complex (B_1 , B_2 , B_5 , i.e., nicotinic acid, B_6 , B_{12} , pantothenic acid and folic acid) and vitamin C.
- (ii) **Fat soluble vitamins :** Vitamins A, D, E and K. They are soluble in liver and adipose (fat storing tissues). However, biotin, i.e., vitamin H is neither soluble in water nor in fat.